



FOAM, GLUE, TAPE AND A LITTLE IMAGINATION....



(RC Model Airplane Construction Plans)

rcFoamFighters

FF-SuperNova

(Original Design by Paul Petty - Feb. 2010)

(CAD Drawing by Paul Petty - Apr 2010)

Basic Template Release Ver. 1.0

FREE PLAN - NOT TO BE SOLD

(Copyright, rcFoamFighters April 2010)

rcFoamFighters

FF-SuperNova Basic Template

(Design by Paul Petty -Feb 2010 - Rev 1.0)

(CAD Drawing by Paul Petty - Apr 2010)

(Basic Template Release 1.0 - Copyright rcFoamFighters)

(Contact rcFoamFighters at: admin@rcfoamfighters.com)

(Please Visit Our Blog at: <http://rcfoamfighters.com/blog/>)

(Copyright, rcFoamFighters April 2010)

Basic Specs as built by rcFoamFighters:

Wingspan: 34 Inches (86.36cm)

Length: 35.7 Inches (90.68cm)

All Up Weight (AUW): 48.6oz. (1377.81gms)

Tested Top Speed: 143mph (230.087kph)

Note, weight and top speed may vary depending on materials, motor, battery and electronics used. The weight given here is based on the model rcFoamFighters made using 1.9 EPP Foam covered in fiberglass weave.

Copy Disclaimer

rcFoamFighters grants permission for this plan to be copied at local copy houses for personal use only. This plan may not be Sold, or Altered to remove the rcFoamFighters contact information or instructions.

(Contact rcFoamFighters at: admin@rcfoamfighters.com)

Top View

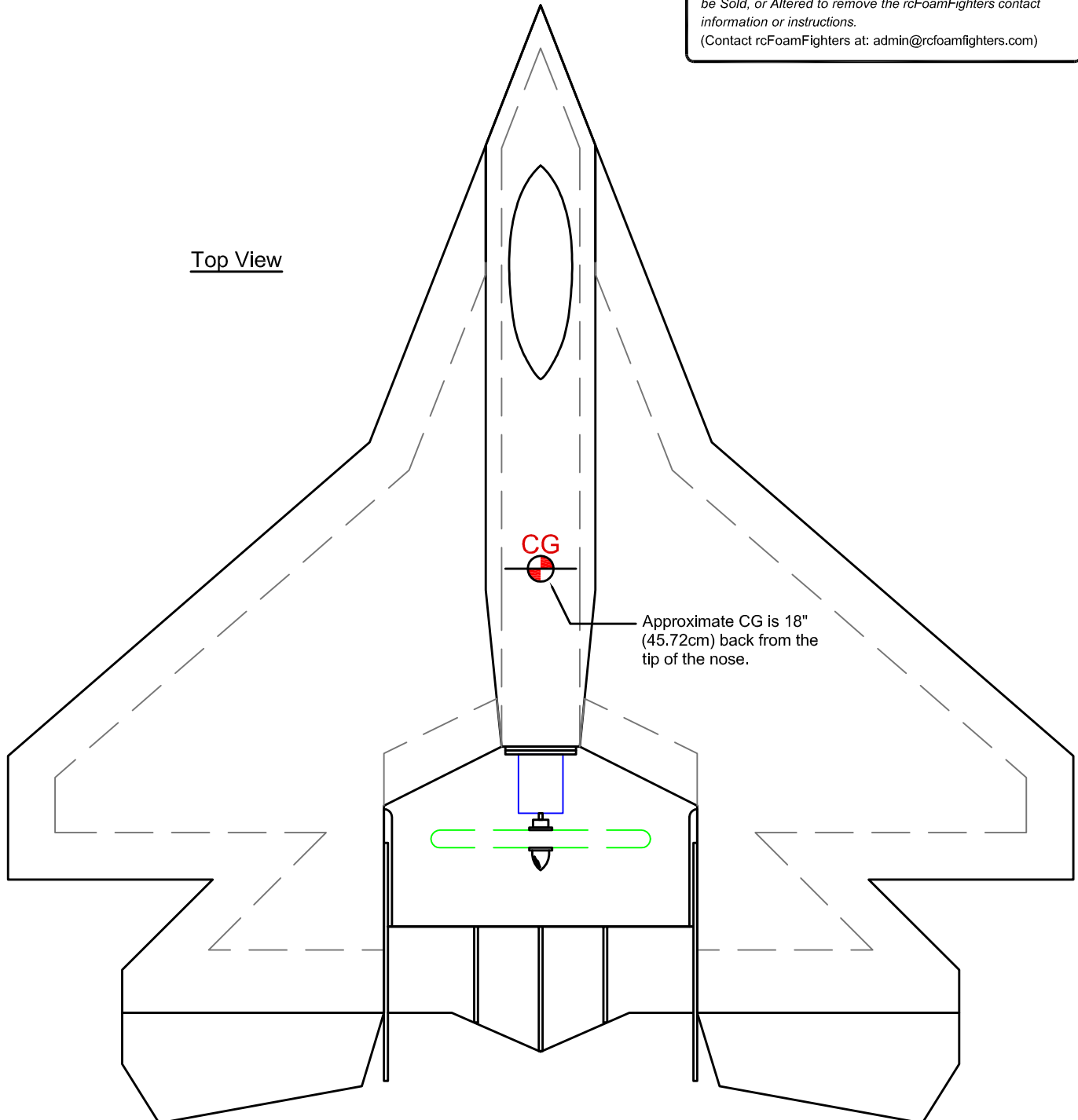

Recommend Parts:

PERFORMANCE SETUP (130+mph)

Motor: TURNIGY 3648-1450 (1600 Watt Brushless Outrunner)

ESC: TURNIGY 100A Brushless ESC

Prop: APC 7X8 SPORTS PROP

Battery: 2650mA 5S (40C recommended)

Servos: 2 Each Metal Gear

Radio & Receiver: Any 4-channel or better (2.4ghz preferred)

Plane was originally designed to be made from 1ea 24x36 Sheet of 30mm 1.9 EPP Foam and 1ea 12x36 Sheet of 15mm 1.9 EPP Foam. Foam was then covered in Henry's style fiberglass weave and 3M 90 adhesive. No spars were required. Other materials than EPP may be used, but carbon fiber or wood spars will be required.

Disclaimer (Please Read):

- This is a design template for a high performance, high speed RC aircraft. This plane should only be built and flown by experienced pilots with adequate skill to fly fast, maneuverable planes.
- **DO NOT fly this plane where it can endanger people, livestock or property.**
- **ANY PERSONS DECIDING TO BUILD AND FLY THIS PLANE DOES SO AT HIS/HER OWN RISK AND LIABILITY. RCFOAMFIGHTERS ASSUMES NO RESPONSIBILITY FOR THE PERFORMANCE OF THIS PLANE.**
- This plane should only be launched via the side launch method. Do not attempt to launch from the top or bottom of the fuselage. Doing so can cause **EXTREME BODILY HARM** if any hand or body part comes into contact with the fast spinning propeller.
- All minors should fly under the supervision of an adult or guardian.

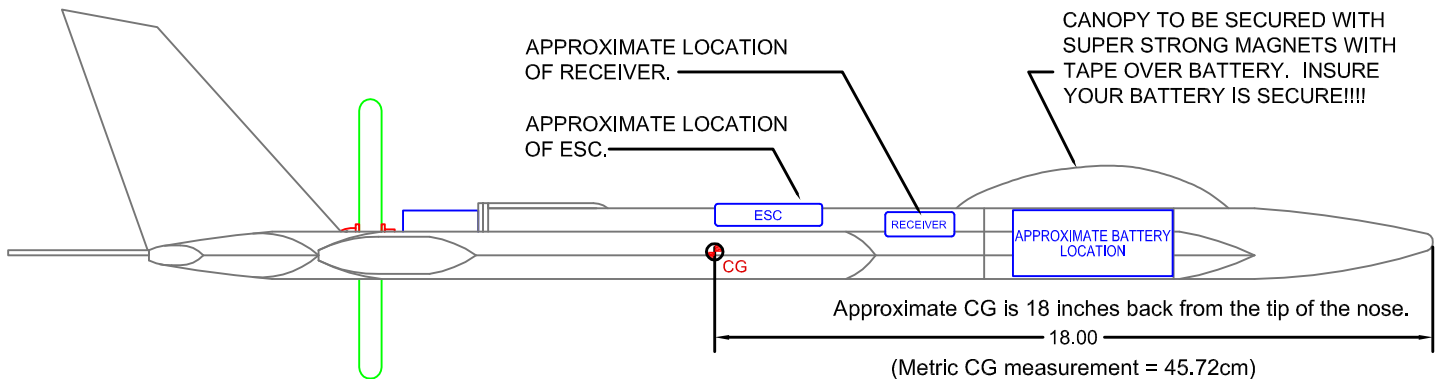

SCRATCH BUILT BASSWOOD MOTOR MOUNT (MADE FROM 1/8" PLYWOOD SHEETS)

SEE NEXT SHEET FOR MOUNT TEMPLATES

ASSEMBLE AS SHOWN.
USE EPOXY OR OTHER
ADHESIVE TO GLUE
TOGETHER.

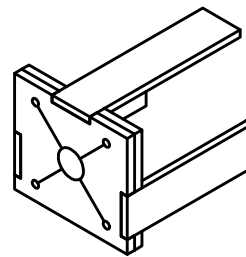
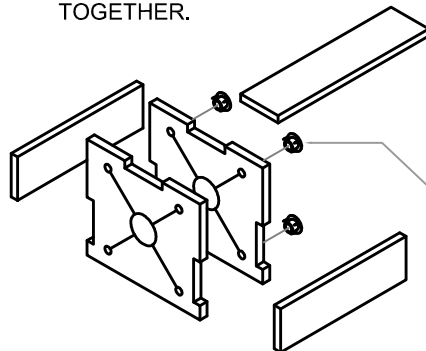

INSERT 4 EACH, 4-40 BLIND NUTS
INTO BACK OF MOTOR MOUNT
PLATE. INSURE HOLE PATTERN IS
DRILLED TO MATCH MOTOR TO BE
USED. (USE 4 EACH 4-40 HEX BOLTS
TO SECURE MOTOR TO MOUNT.)

SCRATCH BUILT PLYWOOD MOTOR MOUNT TEMPLATES (MADE FROM 1/8" PLYWOOD SHEETS)

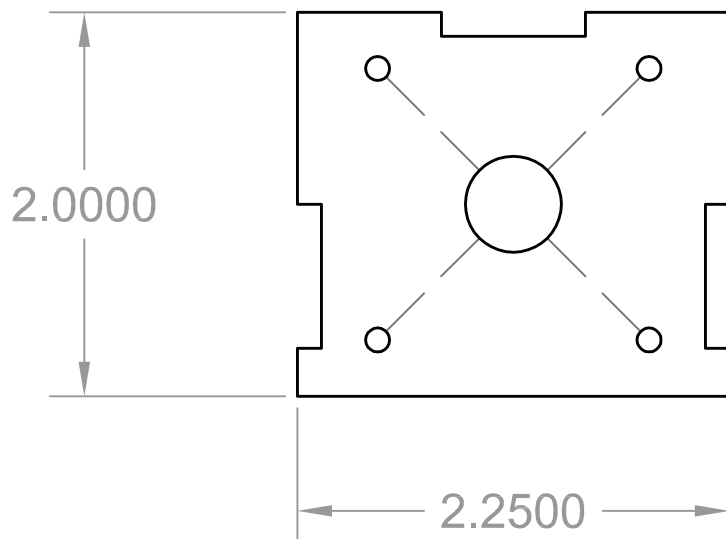
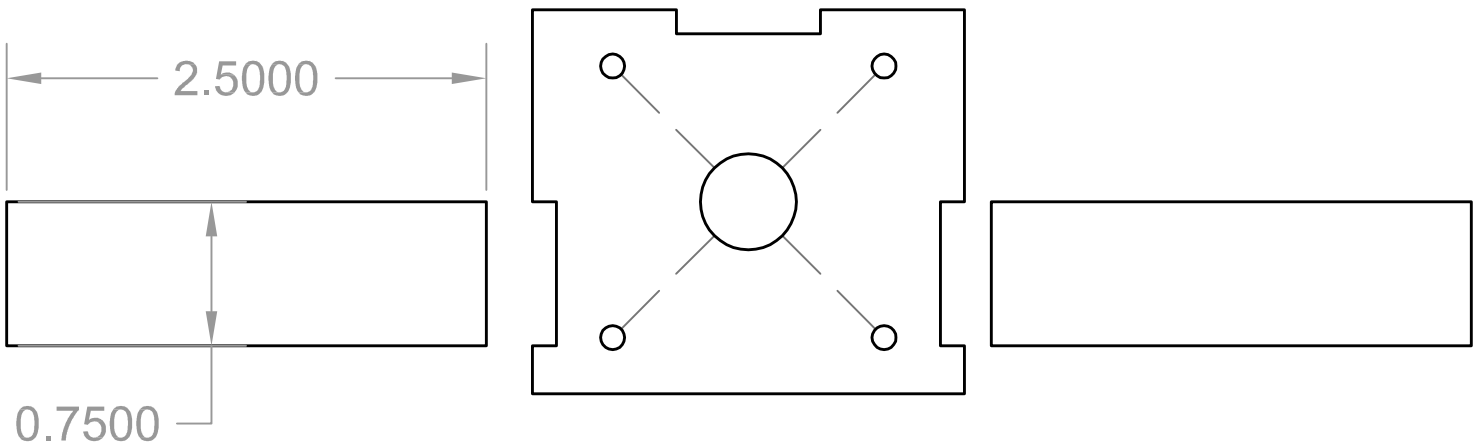
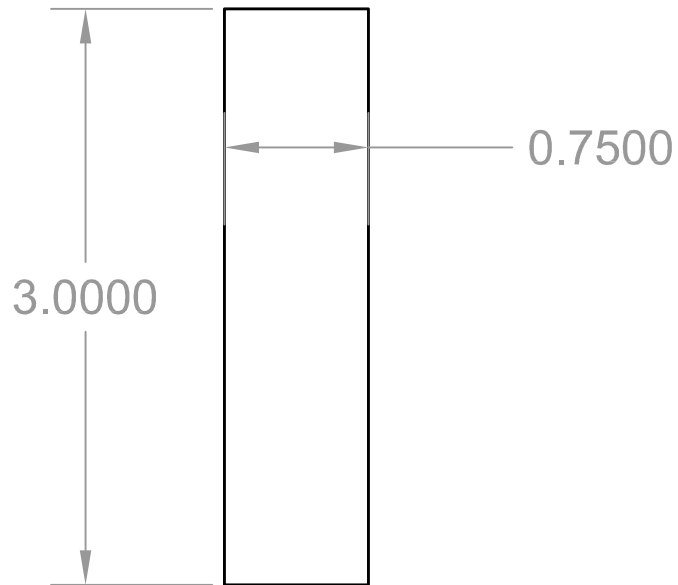

TEMPLATE ASSEMBLY KEY PLAN

rcFoamFighters

FF-SuperNova

(Design by Paul Petty - Feb. 2010 - Rev 1.0)
 (CAD Drawing by Paul Petty - Apr. 2010)
 (Copyright, rcFoamFighters April 2010)

INSTRUCTIONS:
PRINT ALL TEMPLATE SHEETS. CUT AND ASSEMBLE AS SHOWN BELOW. USE SCOTCH TAPE TO SECURE SHEETS TOGETHER.

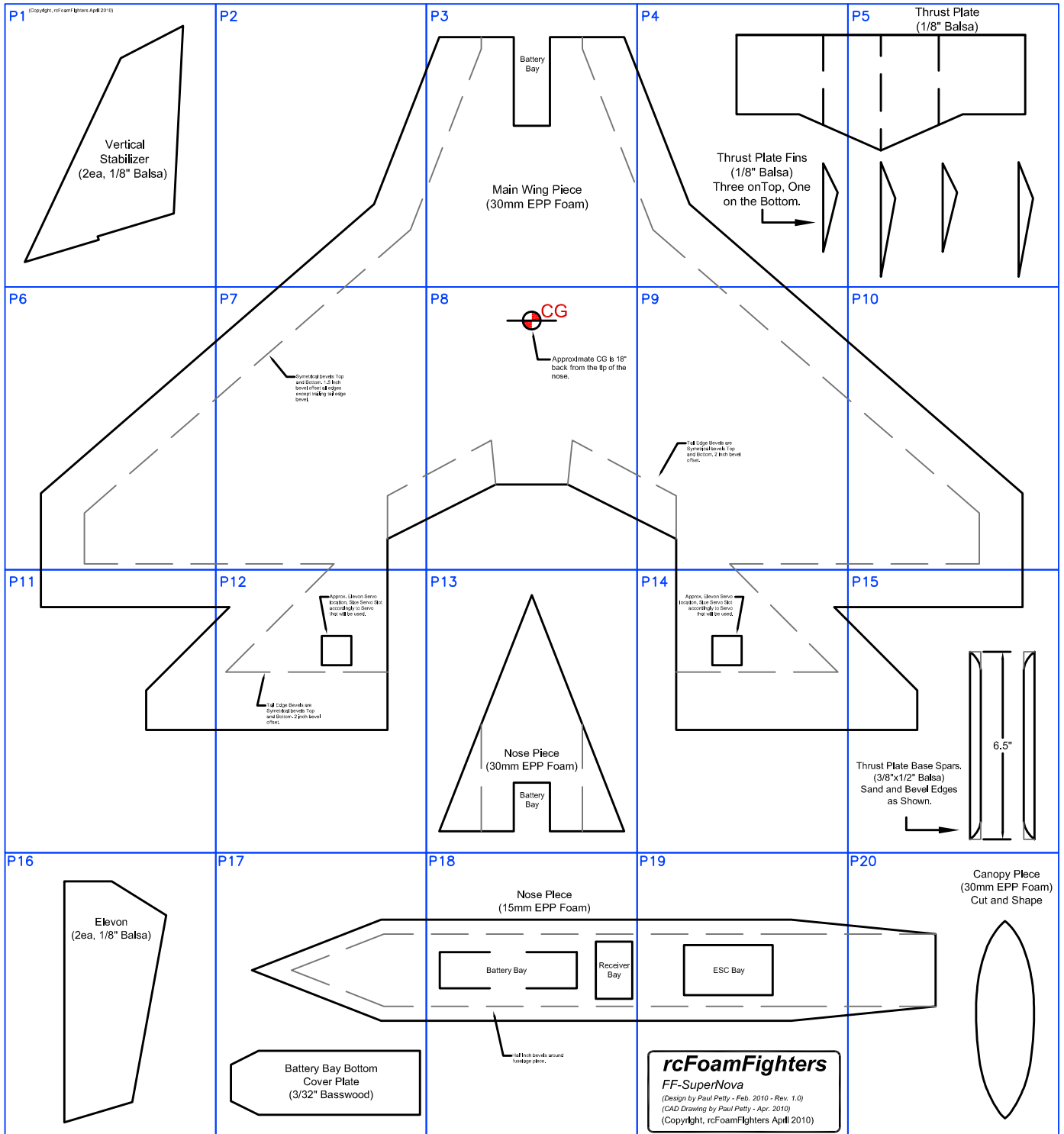

P1

(Copyright, rcFoamFighters April 2010)

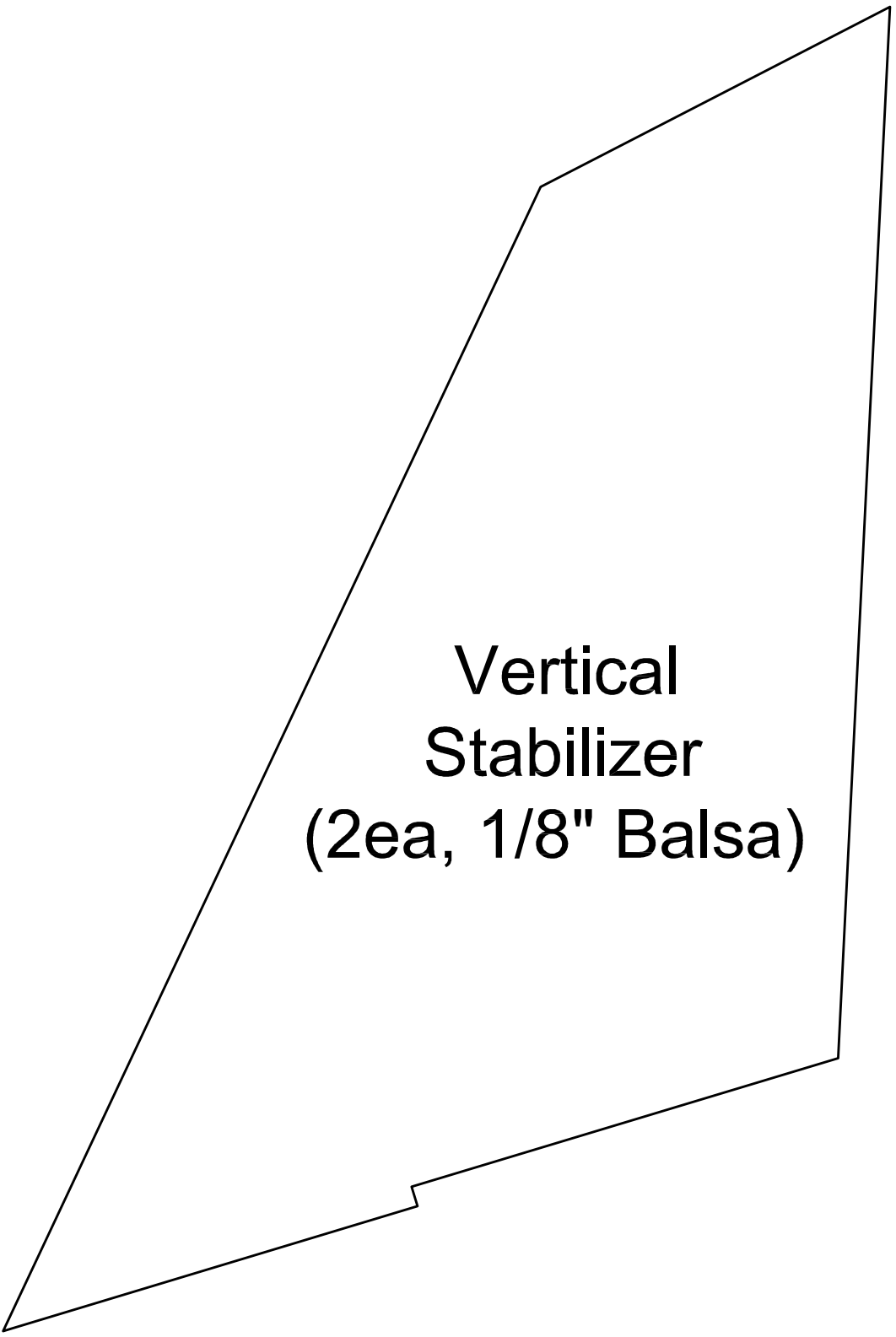

**Vertical
Stabilizer
(2ea, 1/8" Balsa)**

P2

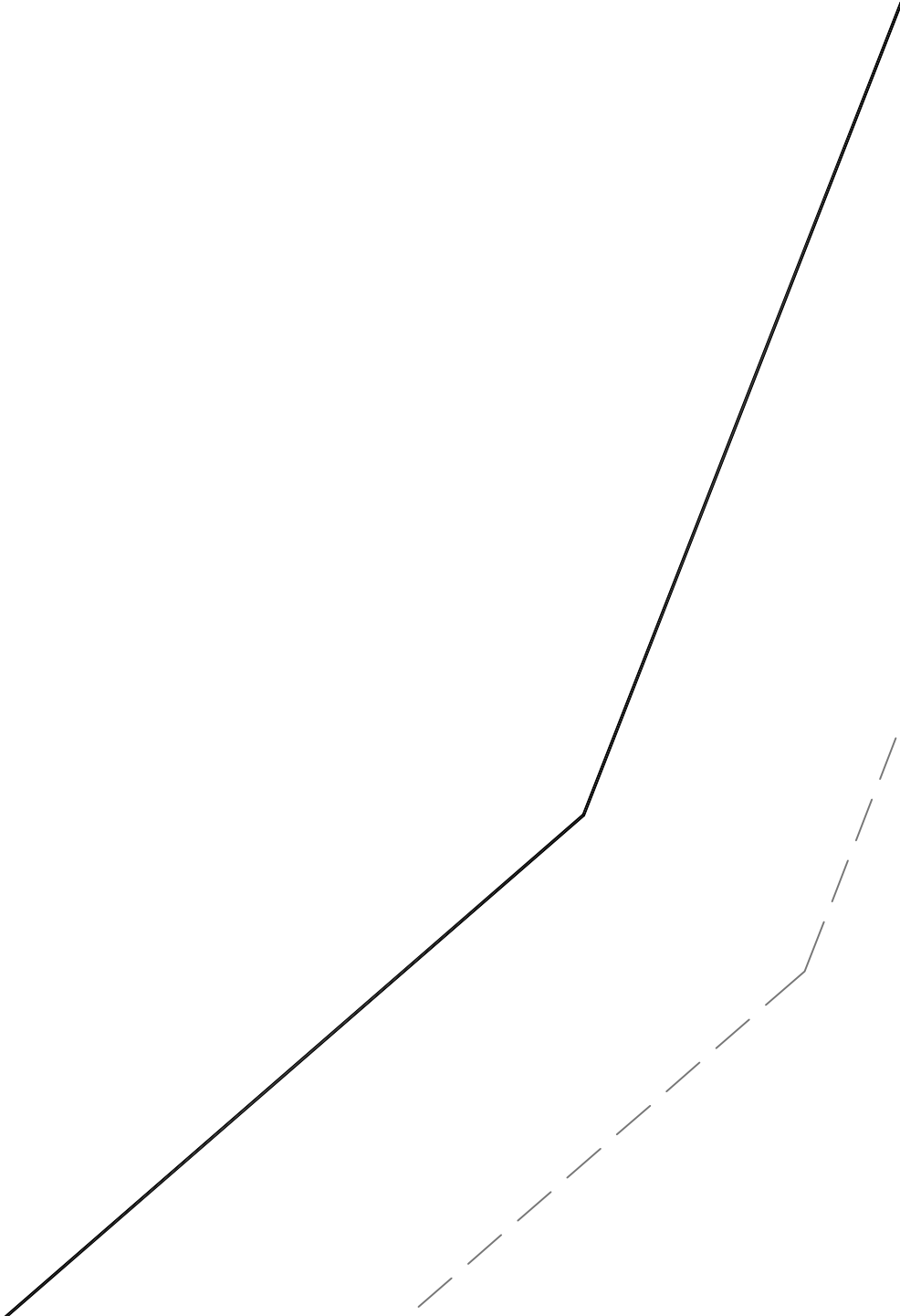

P3

Battery
Bay

**Main Wing Piece
(30mm EPP Foam)**

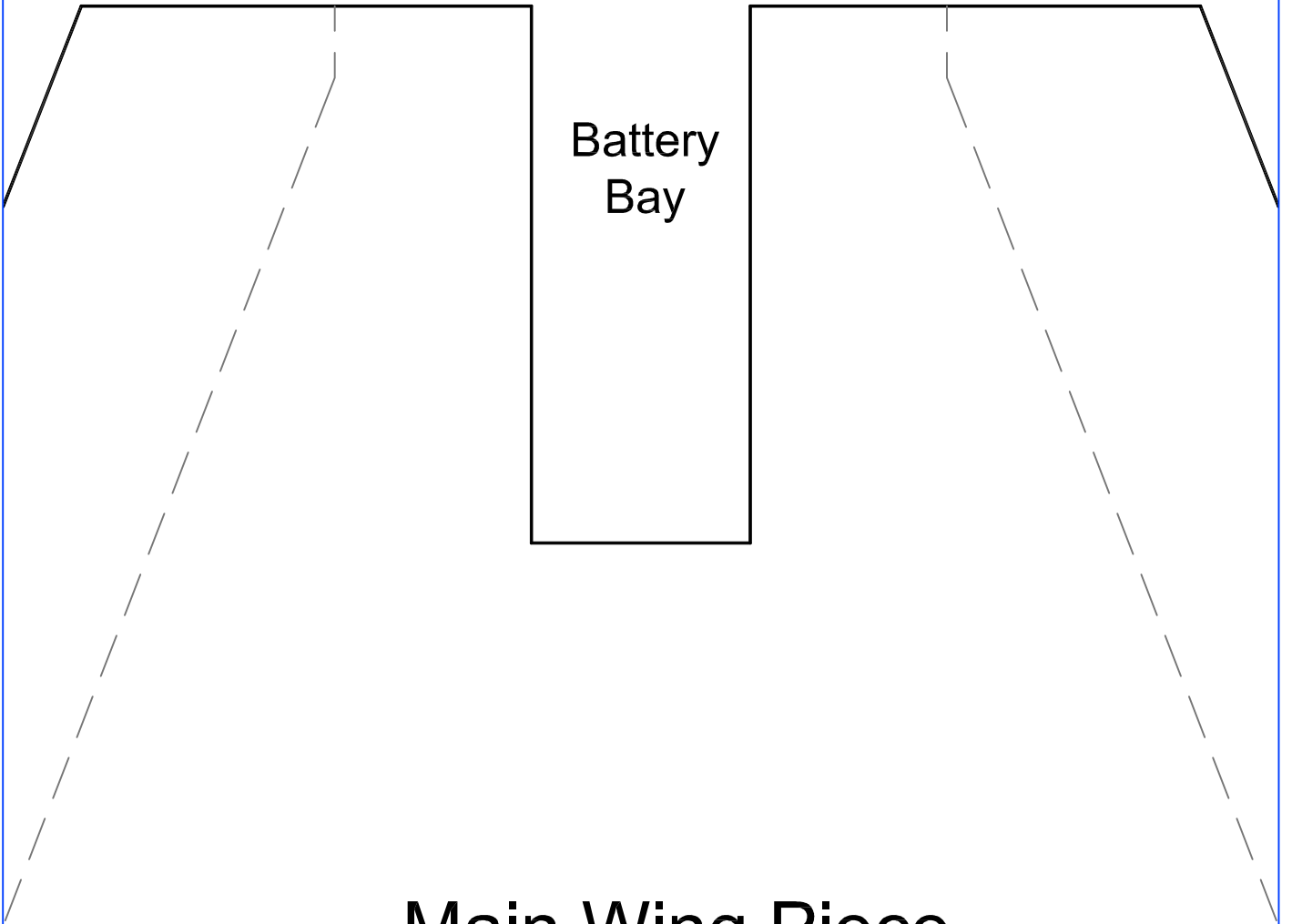

P4

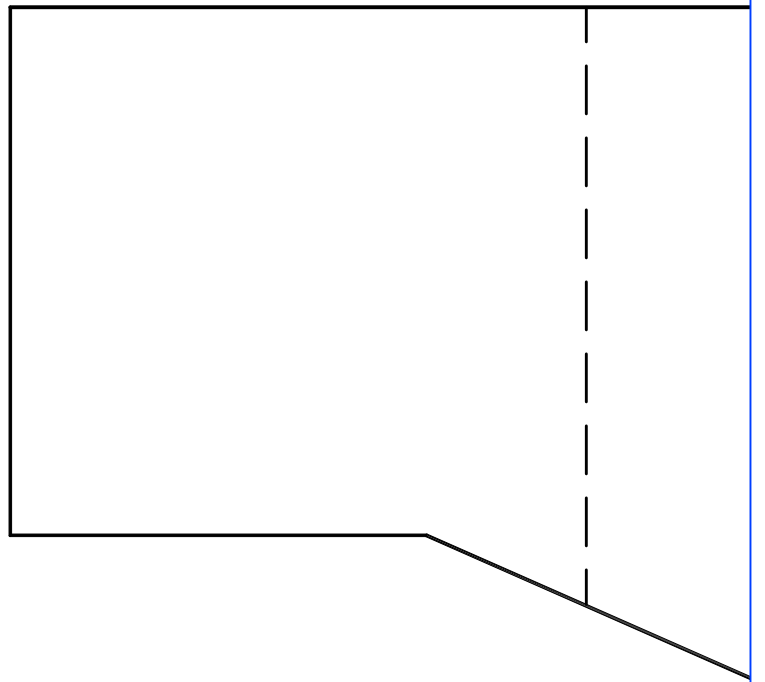

**Thrust Plate Fins
(1/8" Balsa)
Three on Top, One
on the Bottom.**

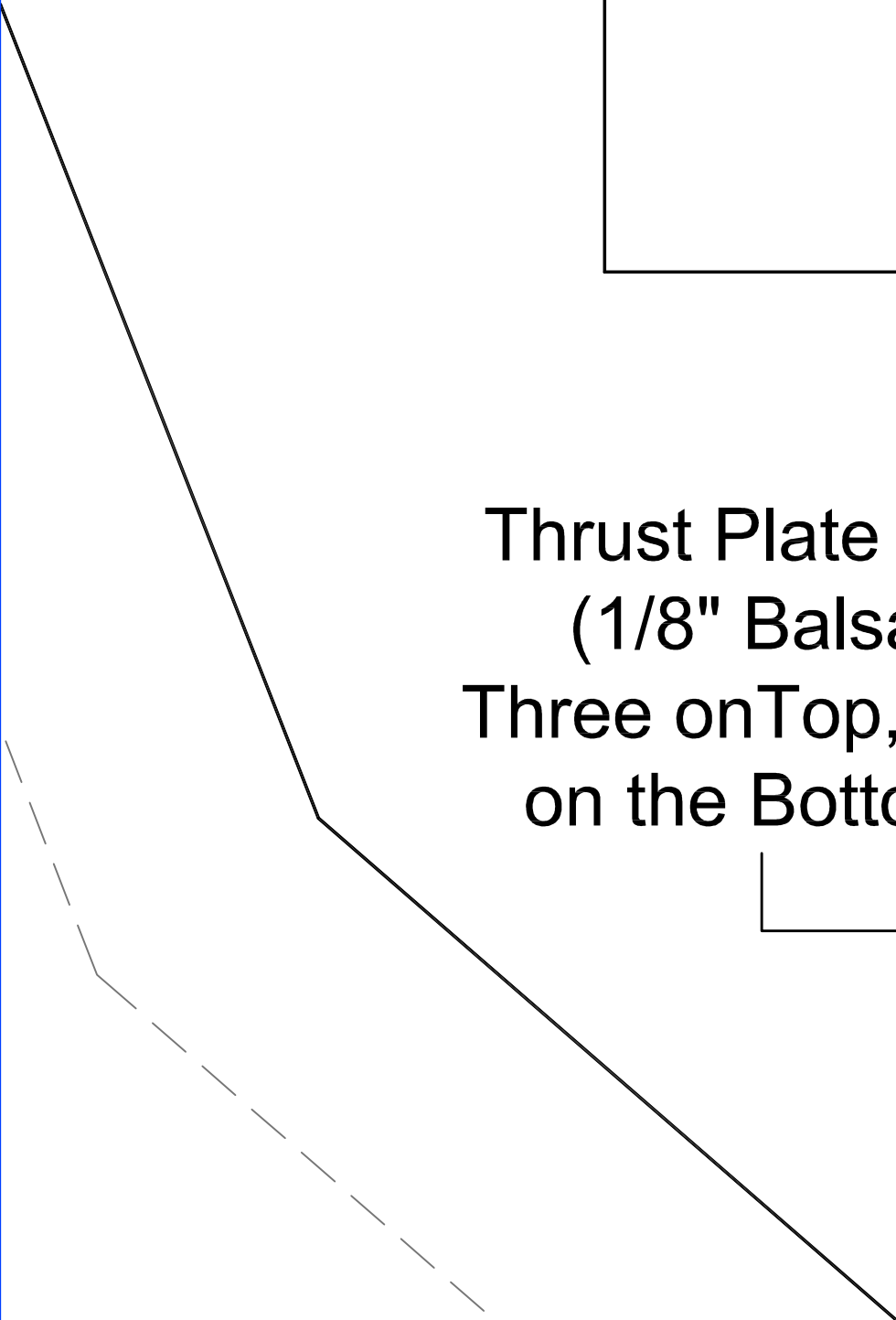
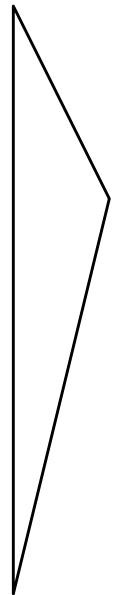
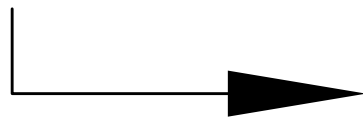

P5

Thrust Plate (1/8" Balsa)

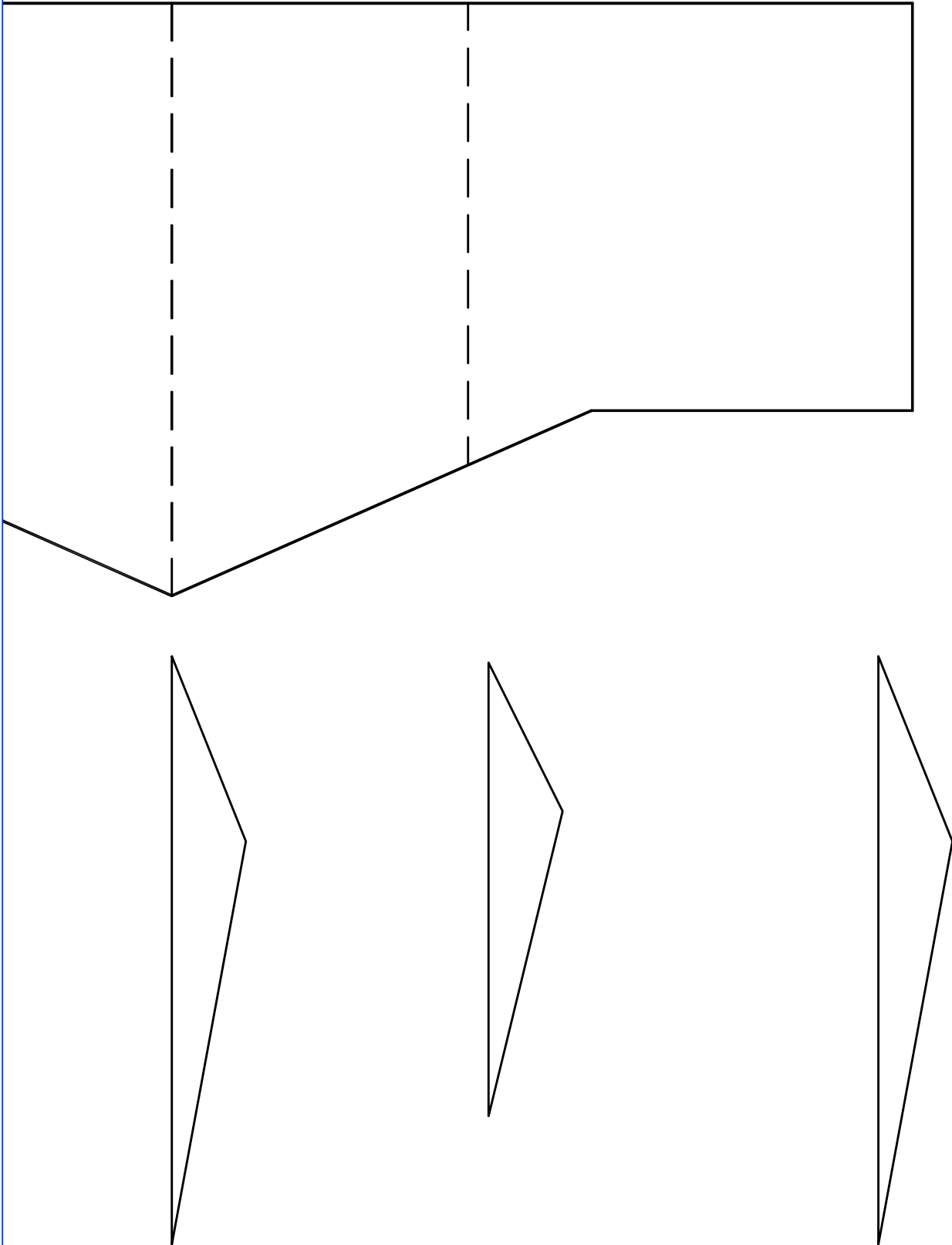

P6

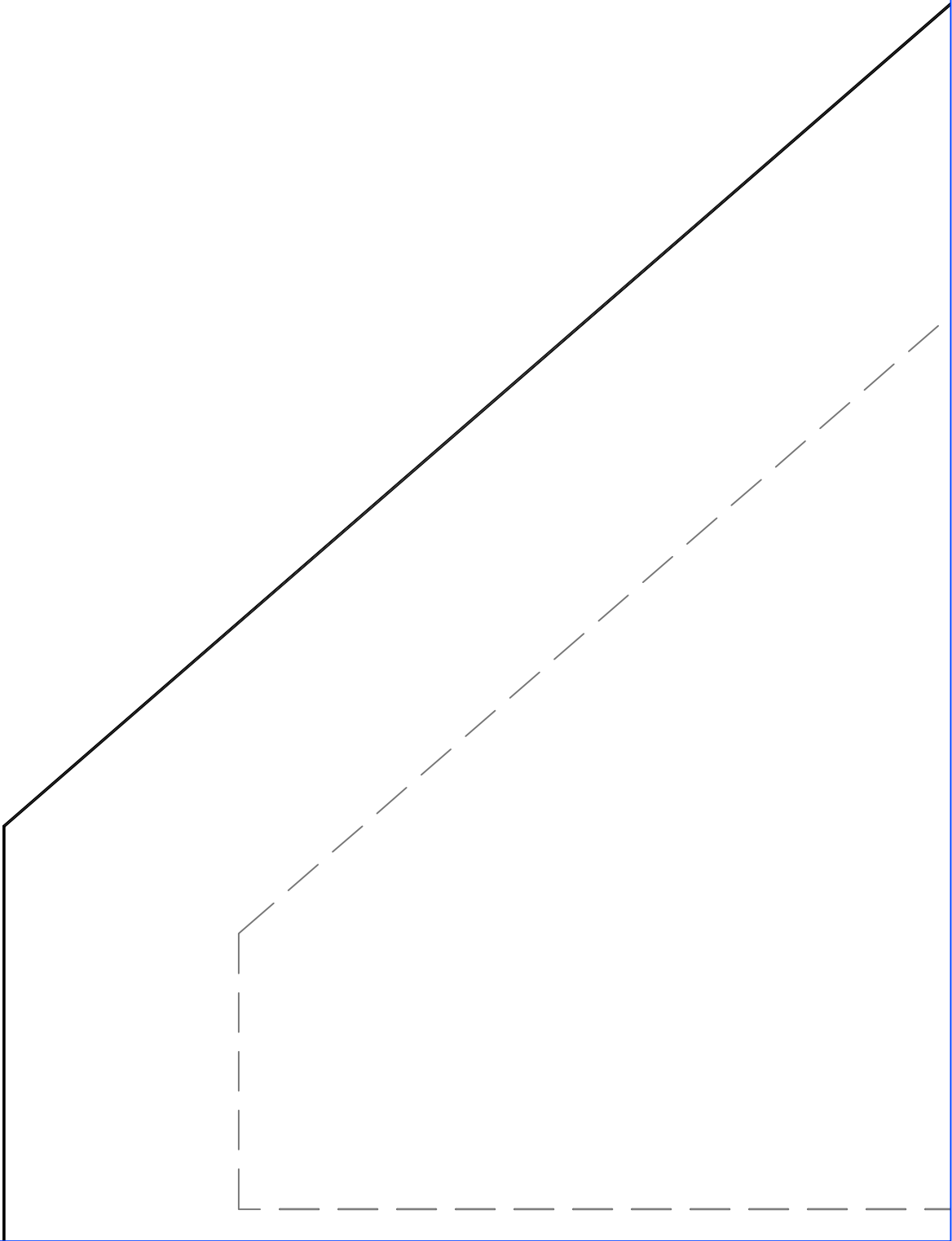

P7

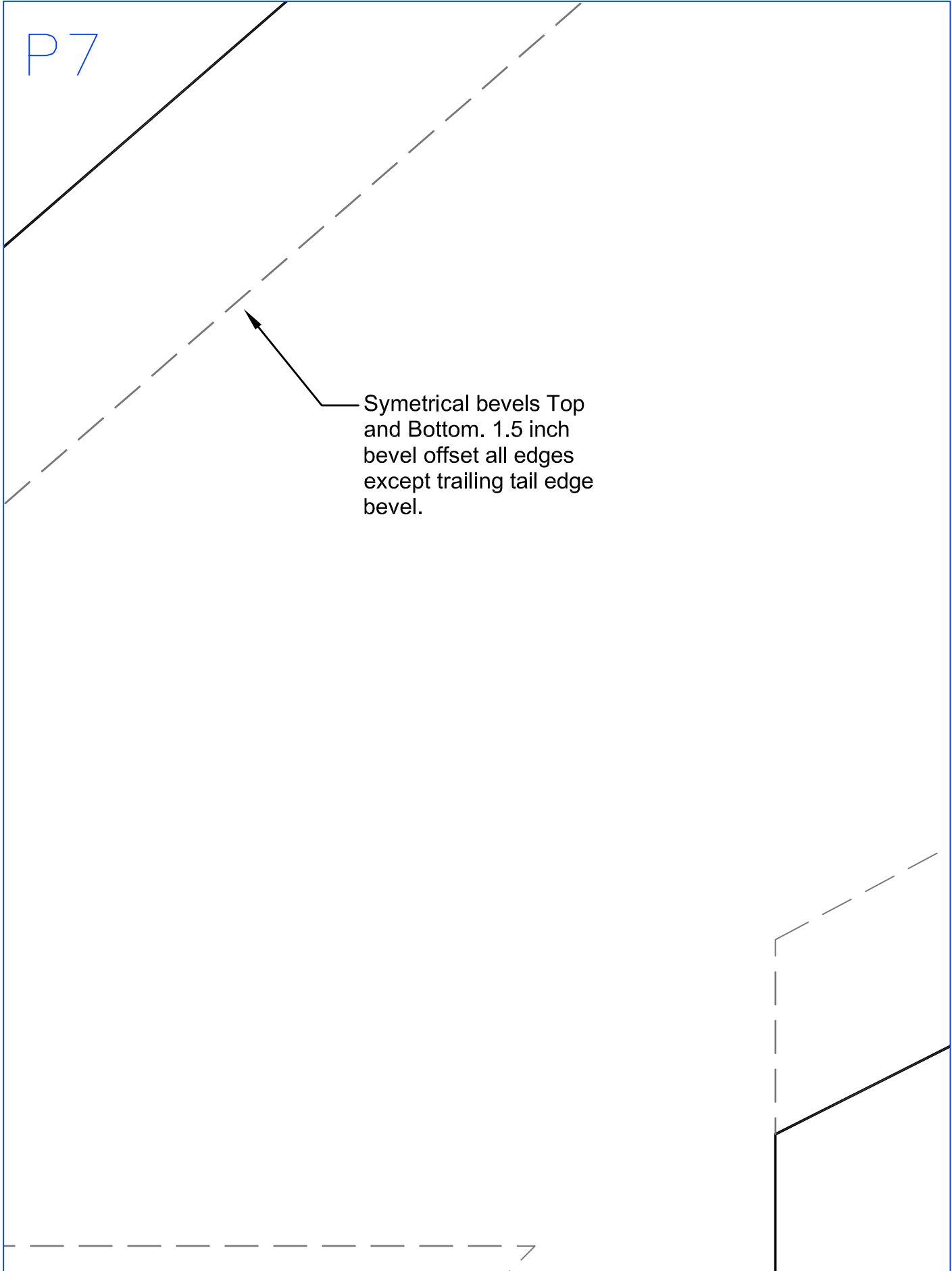

P8

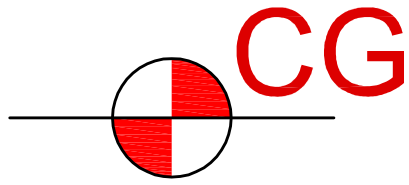

Approximate CG is 18"
back from the tip of the
nose.

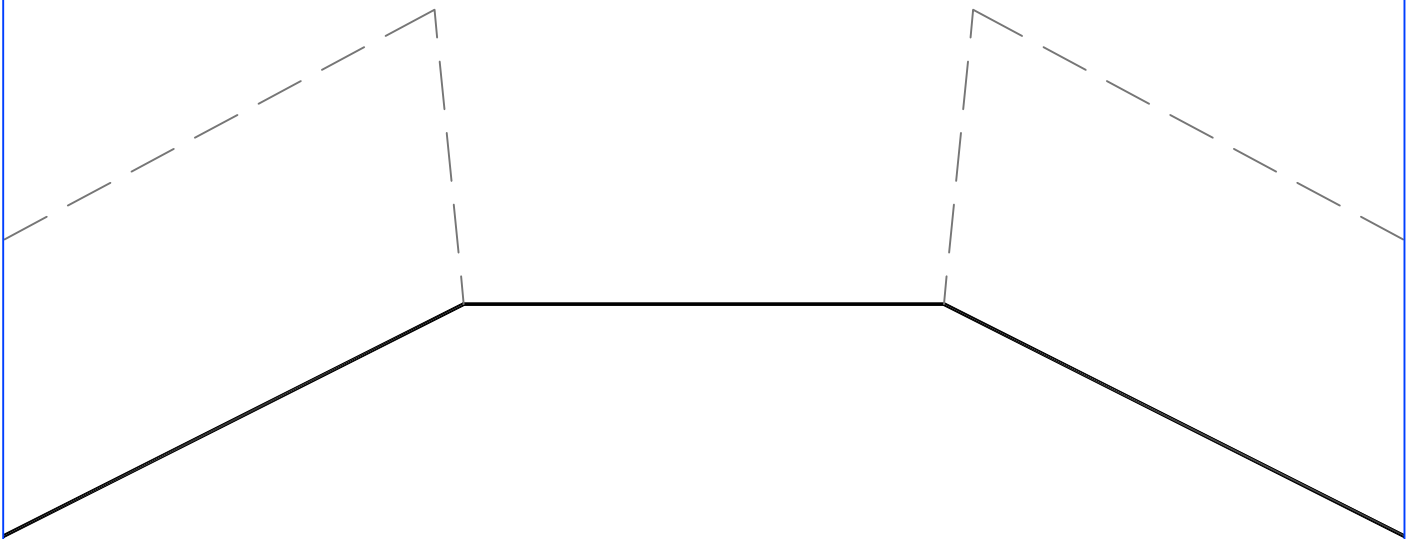

P9

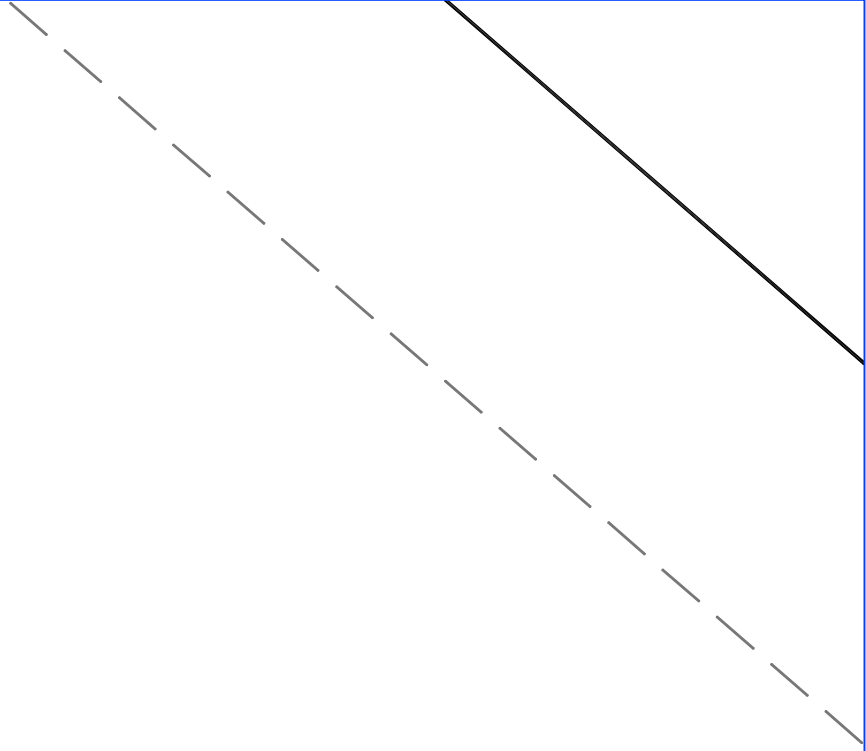

Tail Edge Bevels are Symetrical bevels Top and Bottom. 2 inch bevel offset.

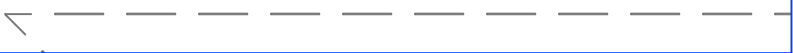
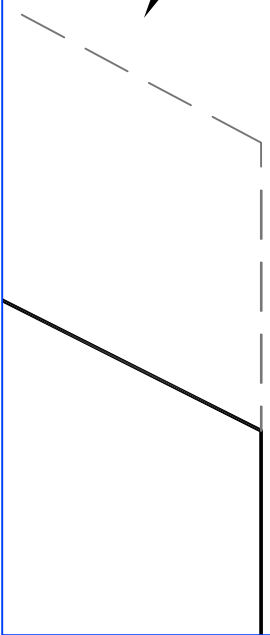
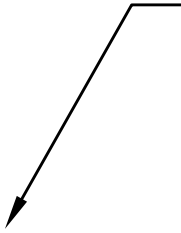

P10

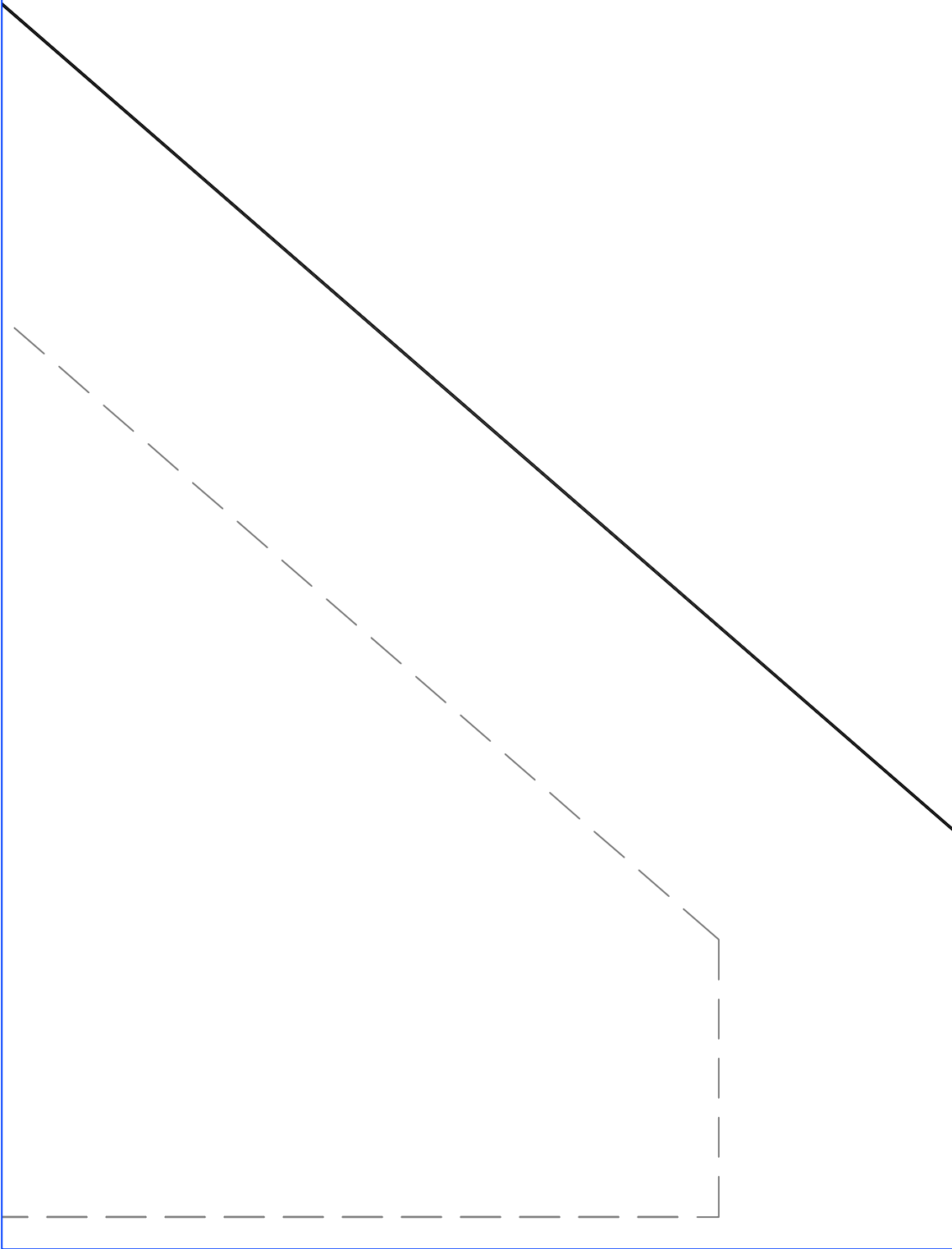

P 11

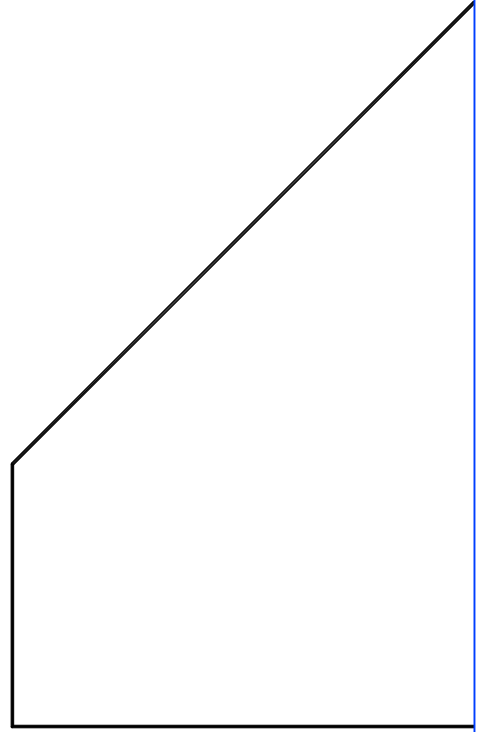
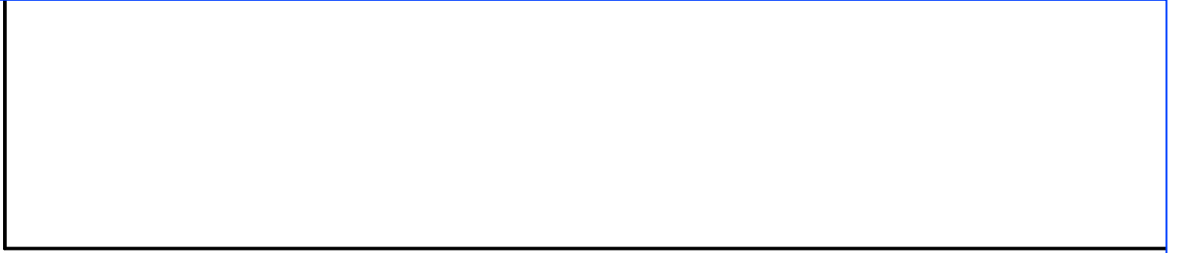

P12

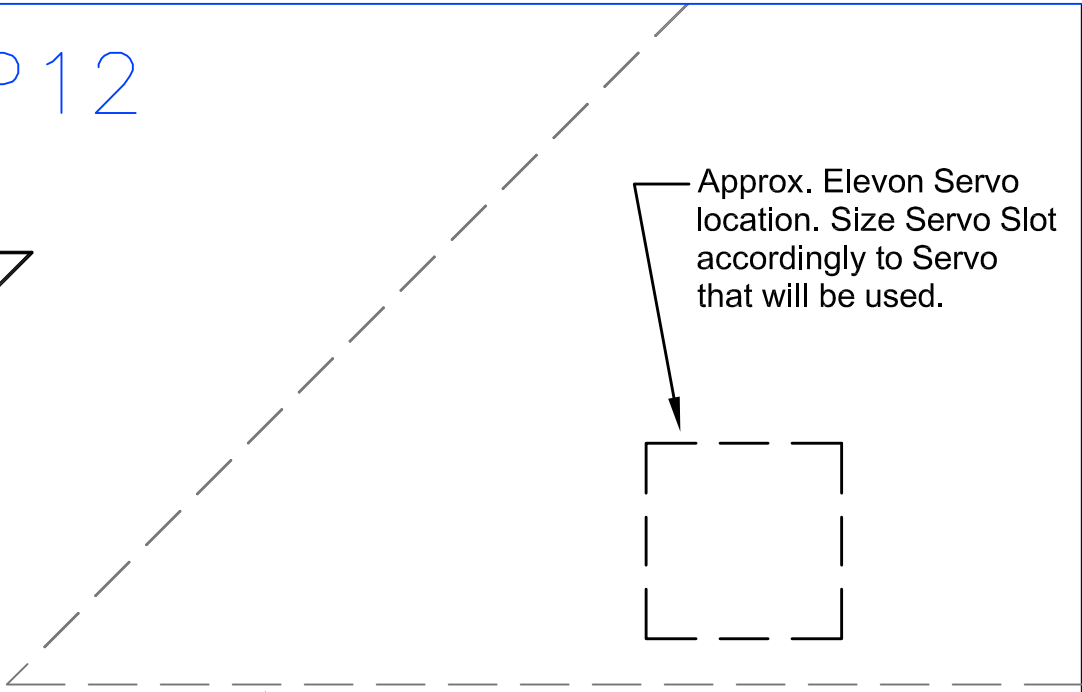
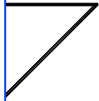

Approx. Elevon Servo location. Size Servo Slot accordingly to Servo that will be used.

Tail Edge Bevels are Symetrical bevels Top and Bottom. 2 inch bevel offset.

P13

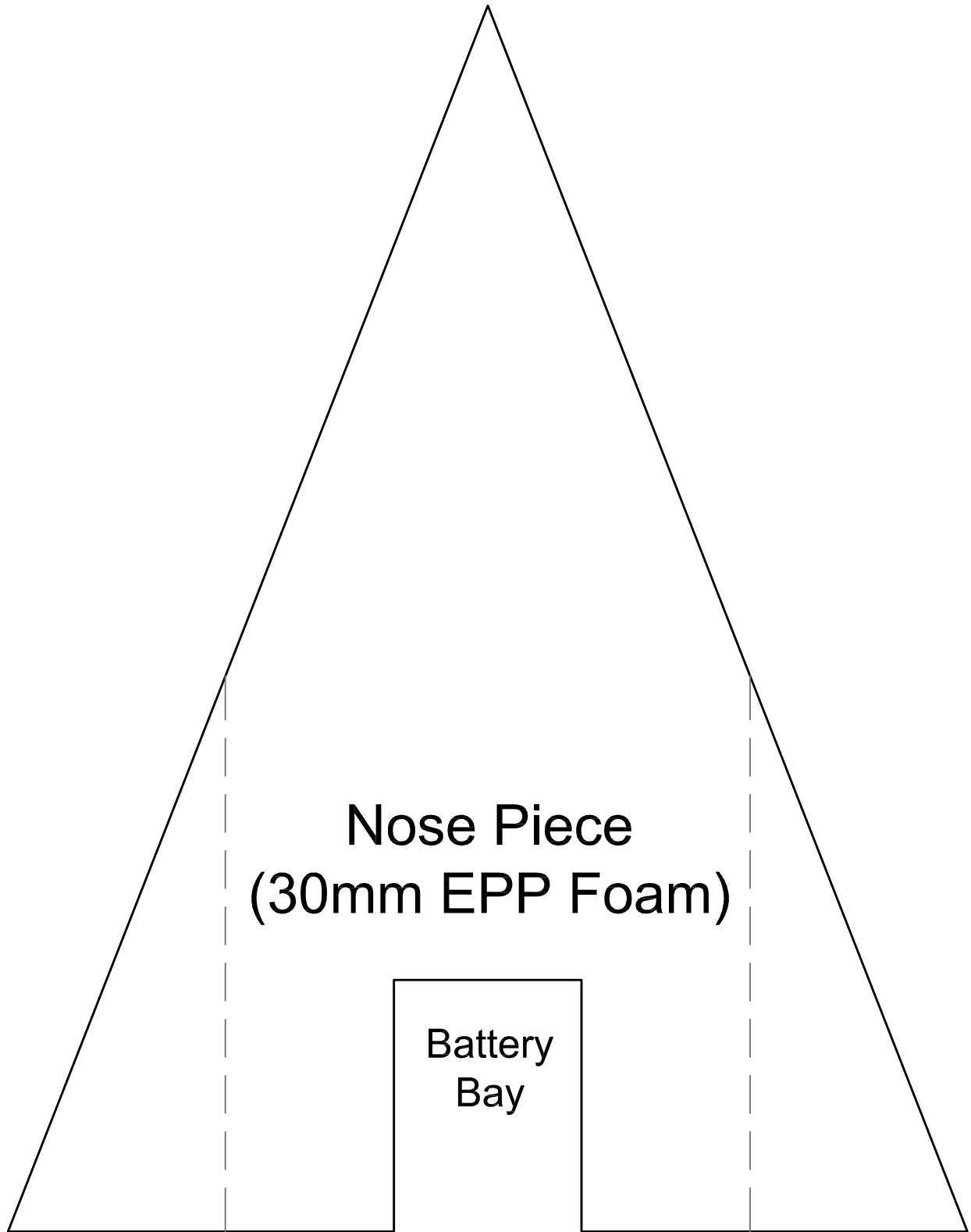

P 14

Approx. Elevon Servo
location. Size Servo Slot
accordingly to Servo
that will be used.

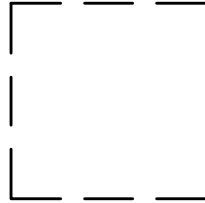

P15

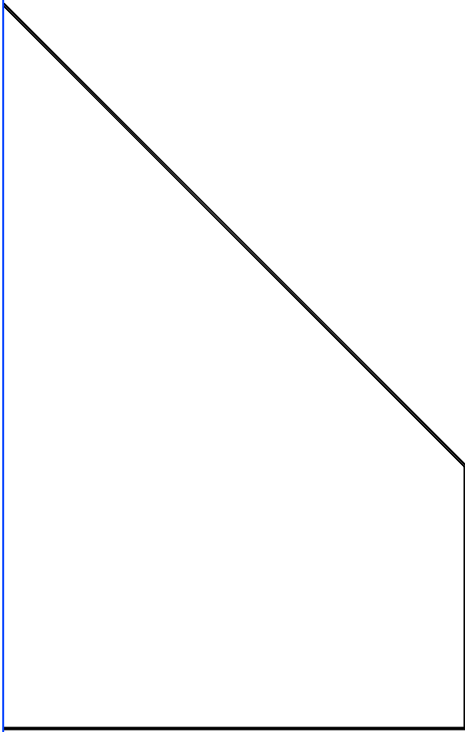

Thrust Plate Base Spars.
(3/8"x1/2" Balsa)
Sand and Bevel Edges
as Shown.

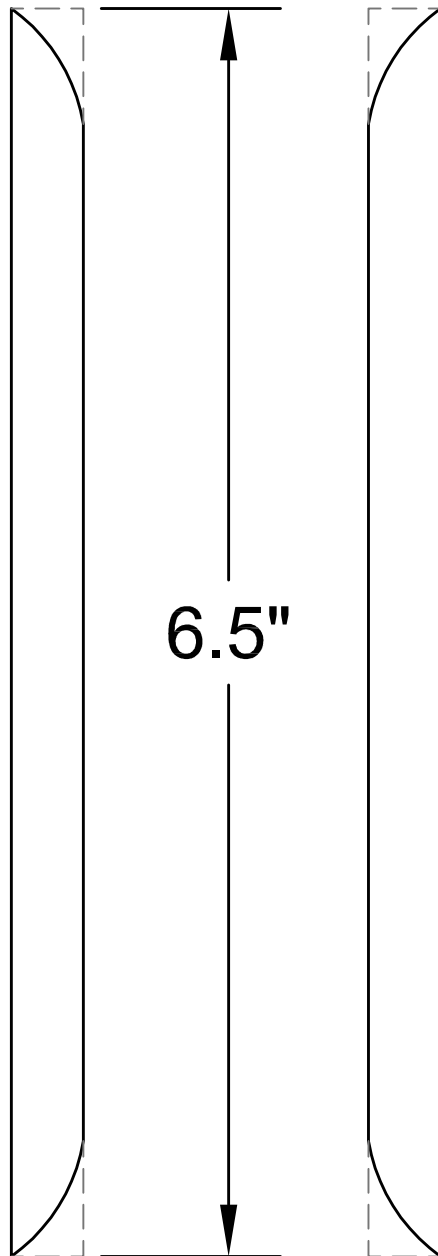
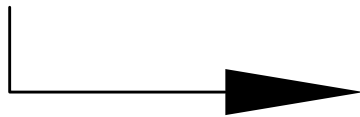

P16

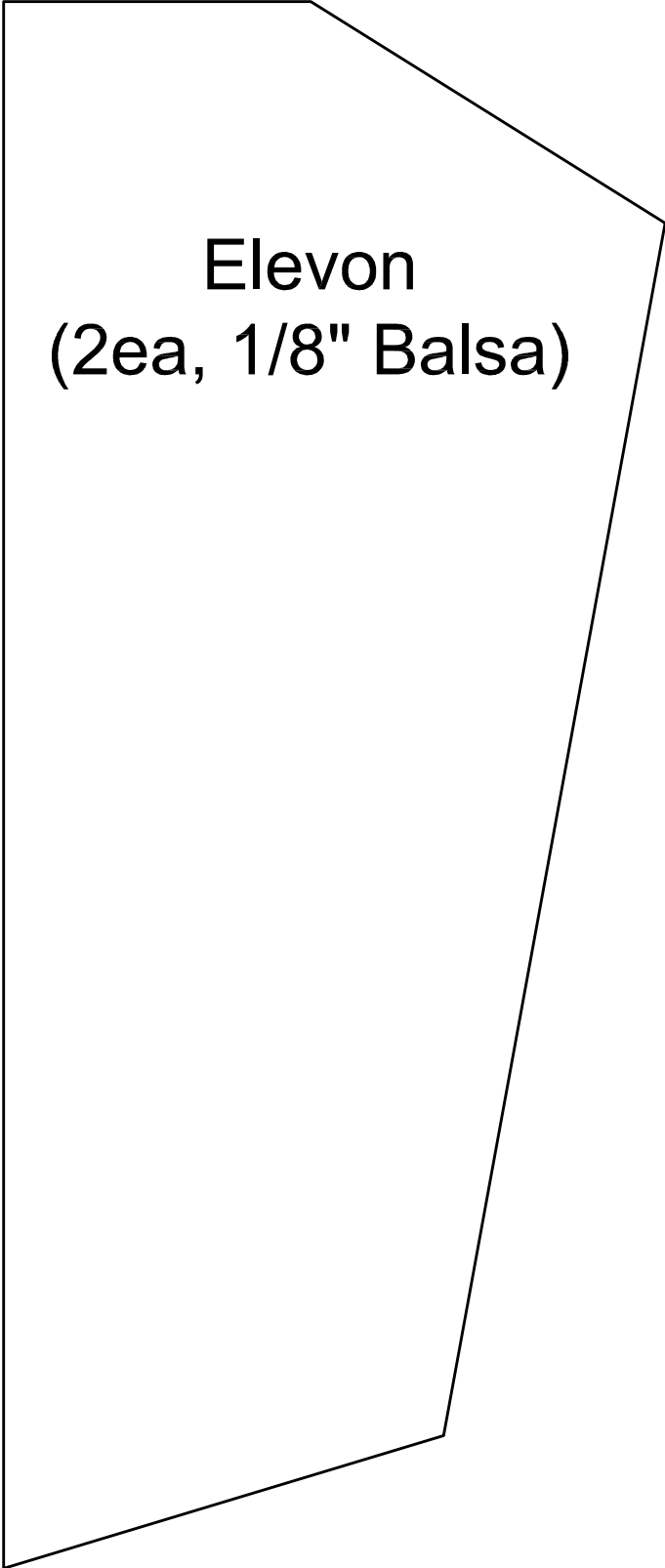

Elevon
(2ea, 1/8" Balsa)

P17

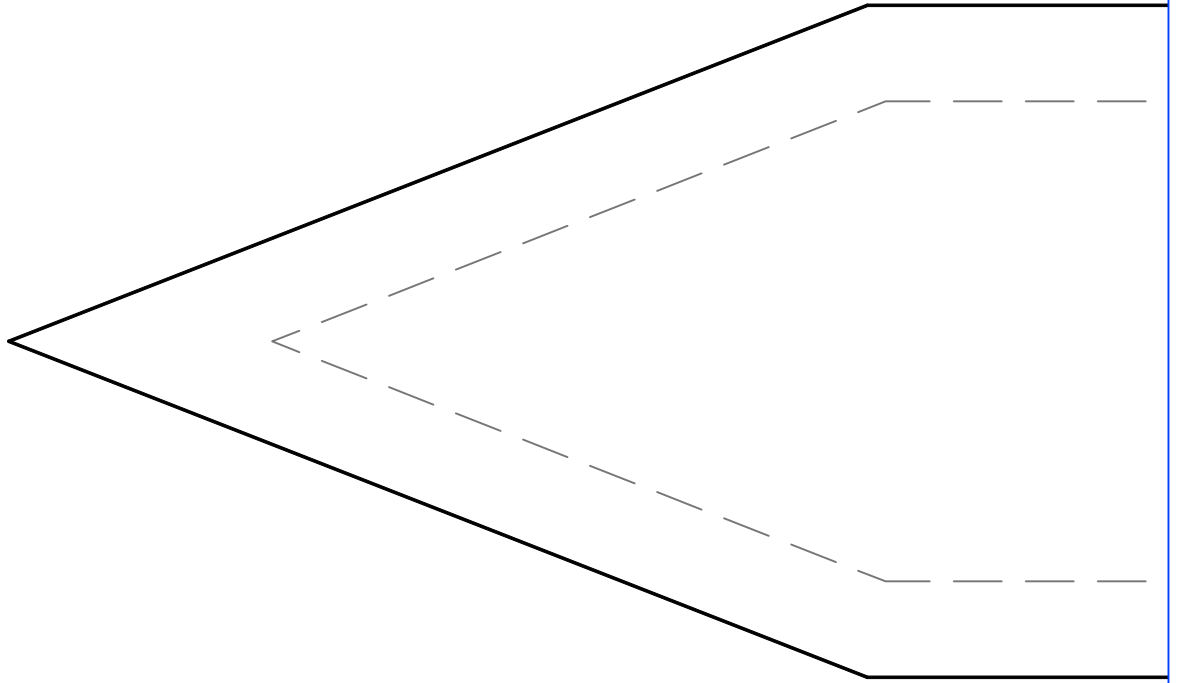

**Battery Bay Bottom
Cover Plate
(3/32" Basswood)**

P18

Nose Piece (15mm EPP Foam)

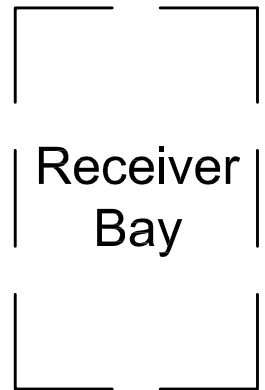
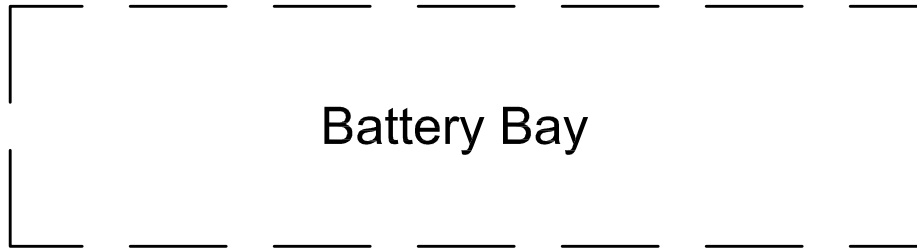

Half inch bevels around
fuselage piece.

P19

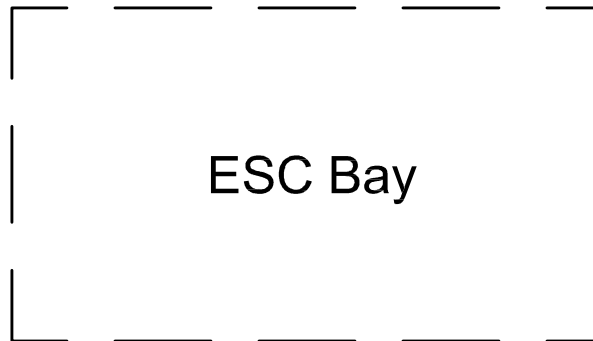

rcFoamFighters

FF-SuperNova

(Design by Paul Petty - Feb. 2010 - Rev. 1.0)

(CAD Drawing by Paul Petty - Apr. 2010)

(Copyright, rcFoamFighters April 2010)

P20

Canopy Piece
(30mm EPP Foam)
Cut and Shape

